

HD34213

Multiplexer

■ Mechanical Drawing

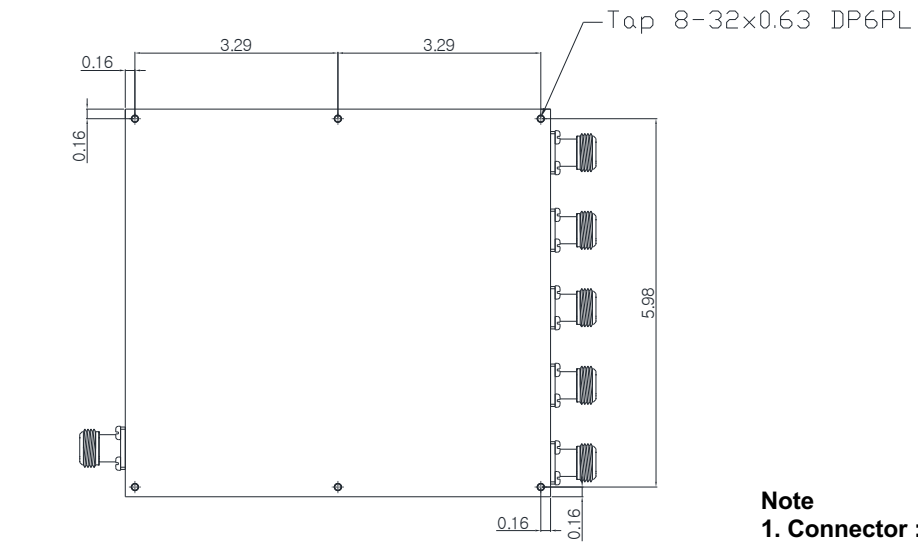
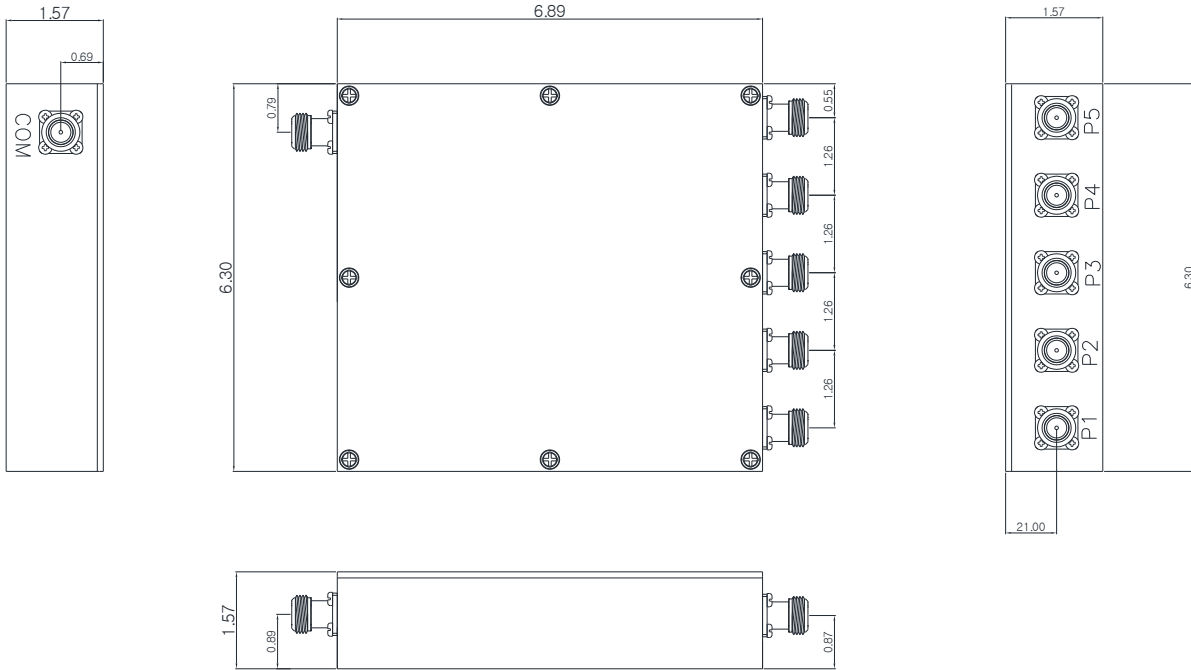

- Note**
1. Connector : N(f) type
 2. Finish : Black epoxy coating

■ **Electrical Specification**

Parameter		Specification	Remark
1. Pass Band Frequency	P1	430MHz~470MHz	
	P2	863MHz~930MHz	
	P3	1200MHz~1610MHz	
	P4	2400MHz~2500MHz	
	P5	5050MHz~5900MHz	
2. Rejection	P1	50dBc Min.@ 863~930MHz	
		50dBc Min.@ 1200~1650MHz	
		50dBc Min.@ 2400~2500MHz	
		50dBc Min.@ 5050~5900MHz	
	P2	30/35dBc Min.(Typ.)@ DC~540MHz	
		25dBc Min.@ 1200~1610MHz	
		50dBc Min.@ 2400~2500MHz	
		50dBc Min.@ 5050~5900MHz	
	P3	25dBc Min.@ DC~930MHz	
		30dBc Min.@ 1910MHz	
		50dBc Min.@ 2400~2500MHz	
		50dBc Min.@ 5050~5900MHz	
	P4	50dBc Min.@ DC~1610MHz	
		25dBc Min.@ 2005 & 4100MHz	
		50dBc Min.@ 5050~5900MHz	
	P5	50dBc Min.@ DC~2500MHz	
50dBc Min.@ 2500~4100MHz			
3dBc Min.@ 6000MHz			
25dB Min.@ 7500MHz			
3. Insertion Loss	P1	0.8dB Max.	
	P2	1.0dB Typ , 1.2dB Max.	
	P3	1.0dB Typ , 1.2dB Max.	
	P4	0.5dB Typ , 0.6dB Max.	
	P5	0.4dB Typ , 0.6dB Max.	
4. Band Ripple		0.8dB Max.(P-T-P)	

5. Return Loss		P1~P2: 14dB Min	
		P3 : 12dB Min	
		P4~P5 : 14dB Min	
6. Isolation	All Filters	50dB Min.	
	P2 & P3	25dB Min.	
7. RF Power Handling		Each channel : 50W avg. Com: 335W Max.	
8. Impedance		50Ω	
9. Operating temp		-20 ~ +75 °C	
10. Application		IP65	

■ Test Curve

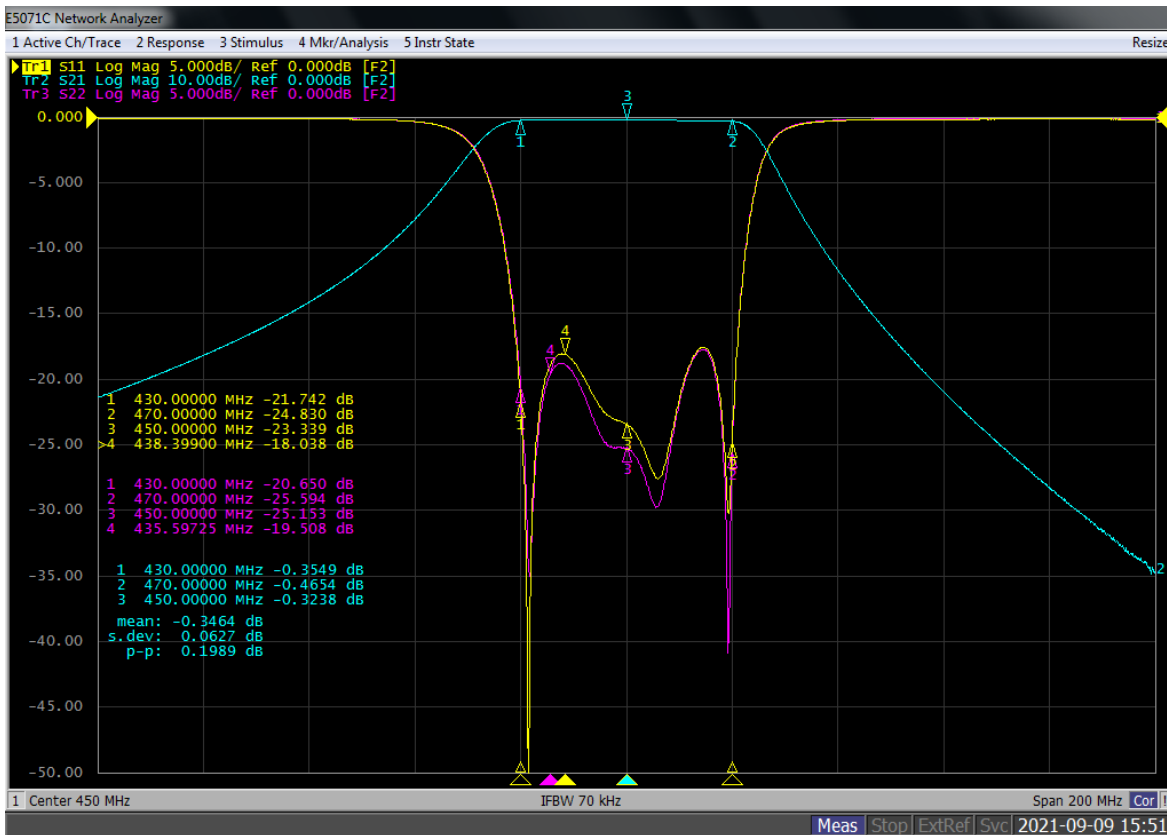

<P1>

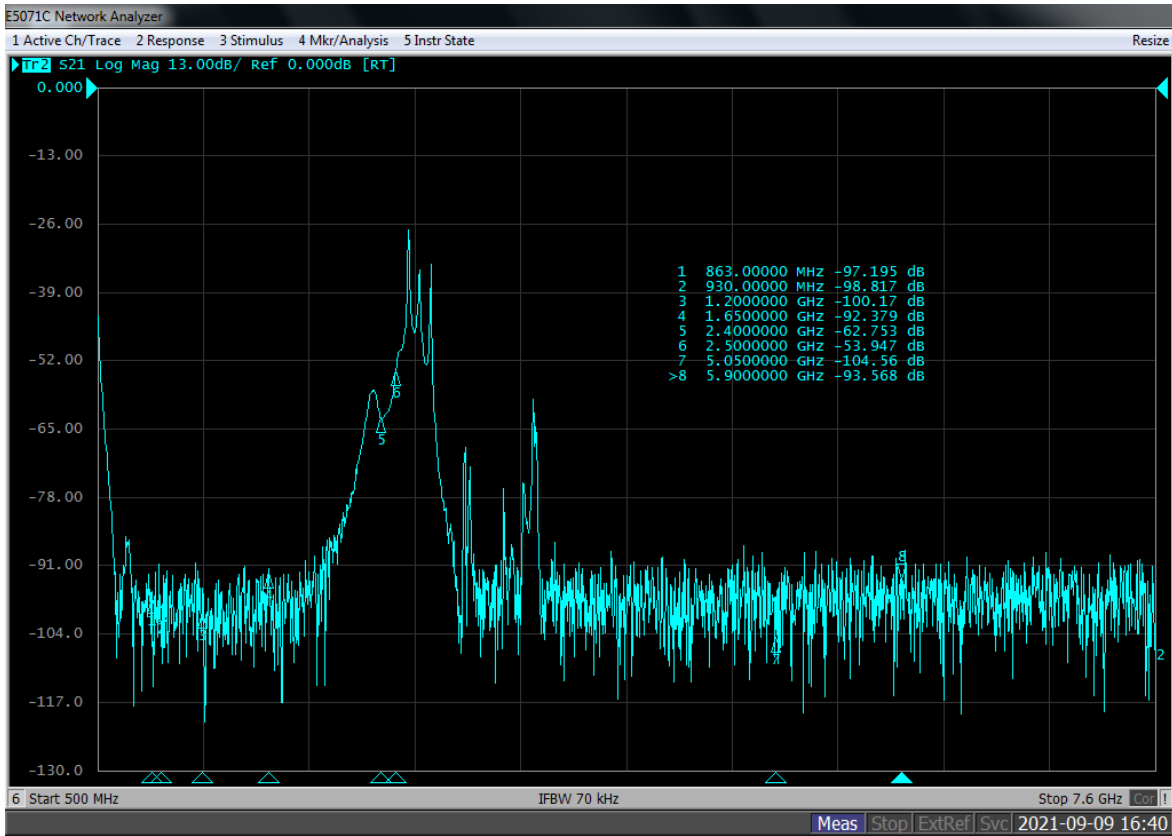

<P1 ISO>



<P2>

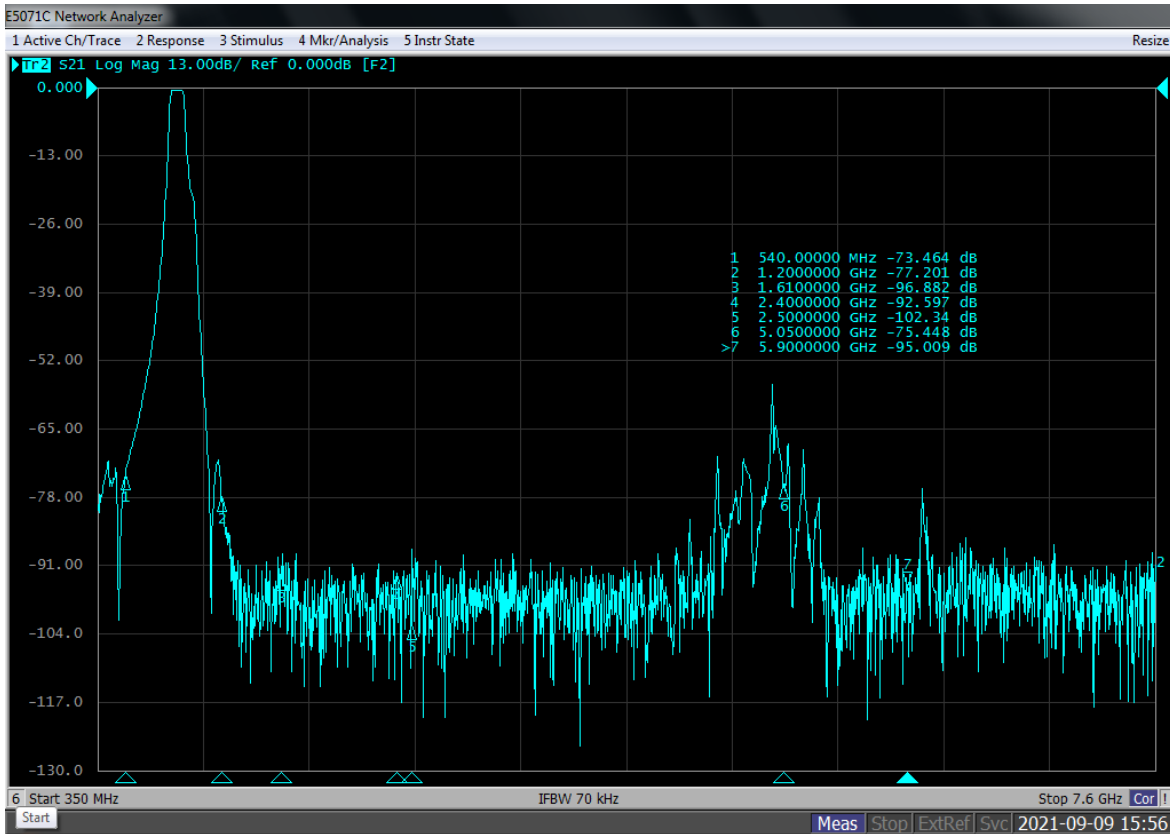

<P2 ISO>



<P3>

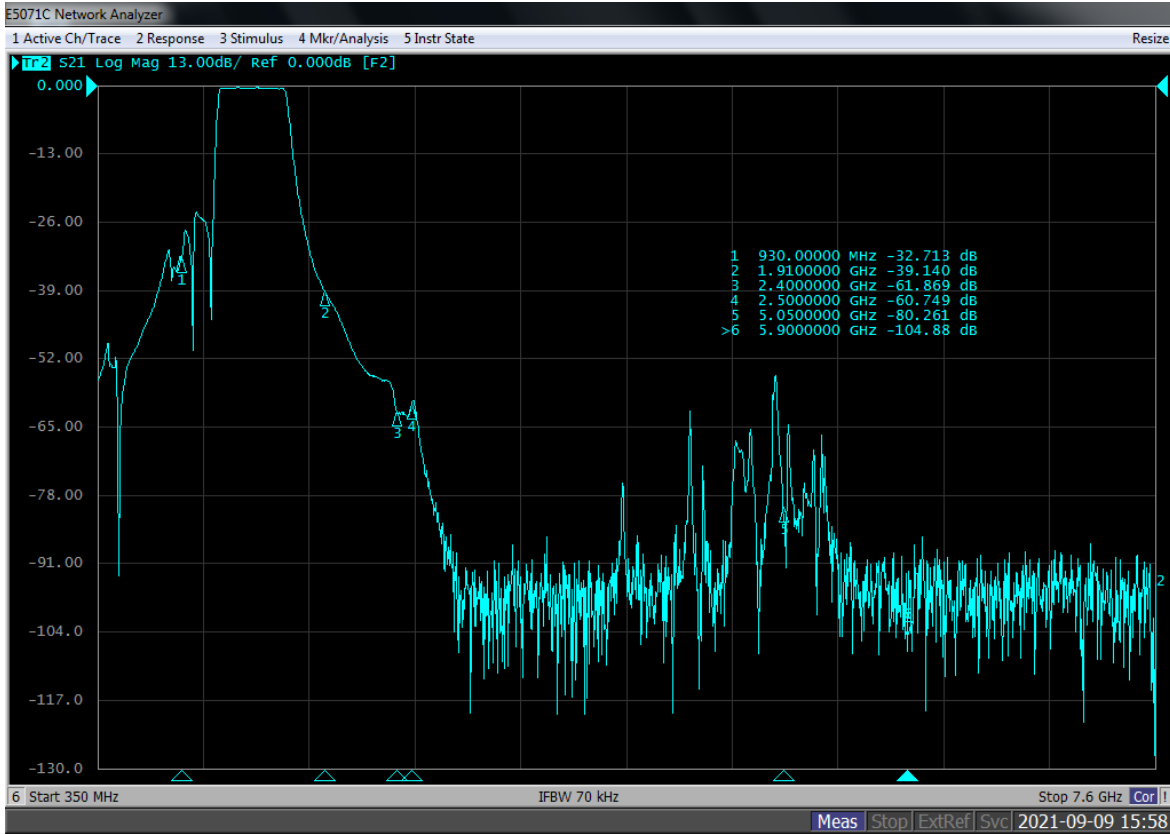

<P3 ISO>

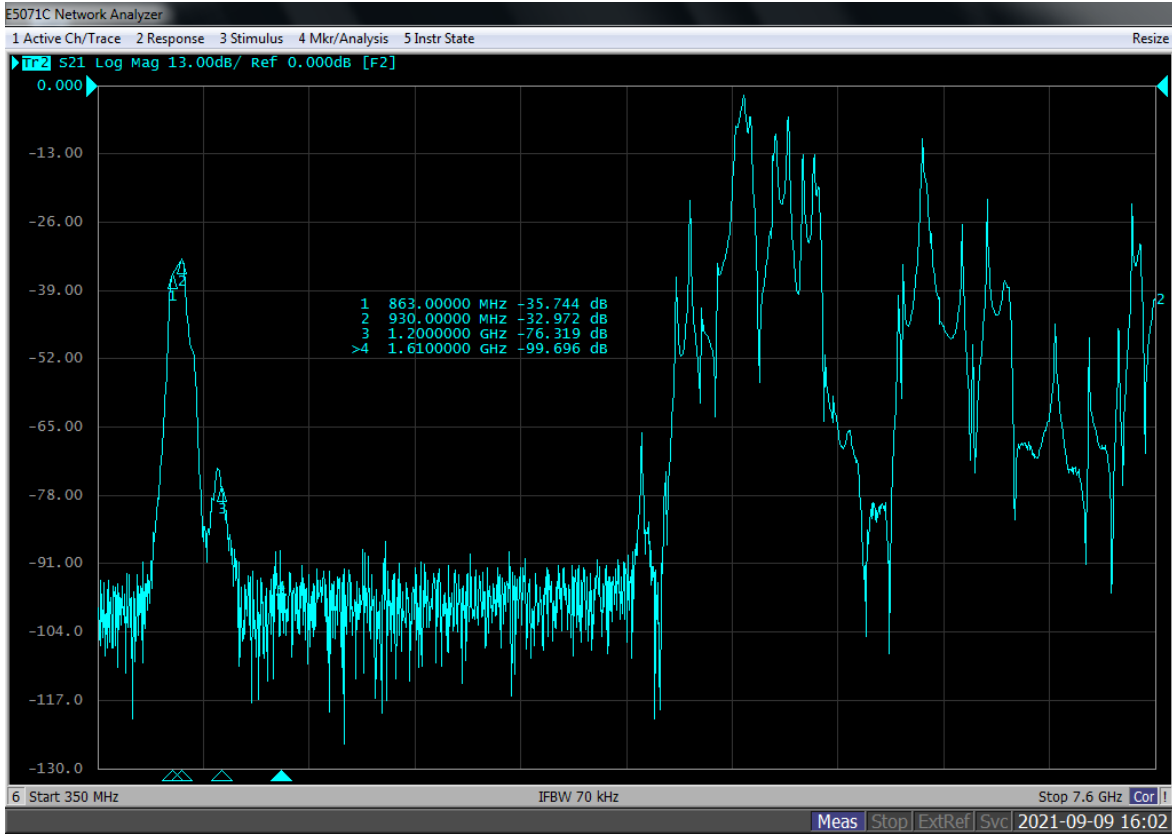

<P2/P3 ISO>

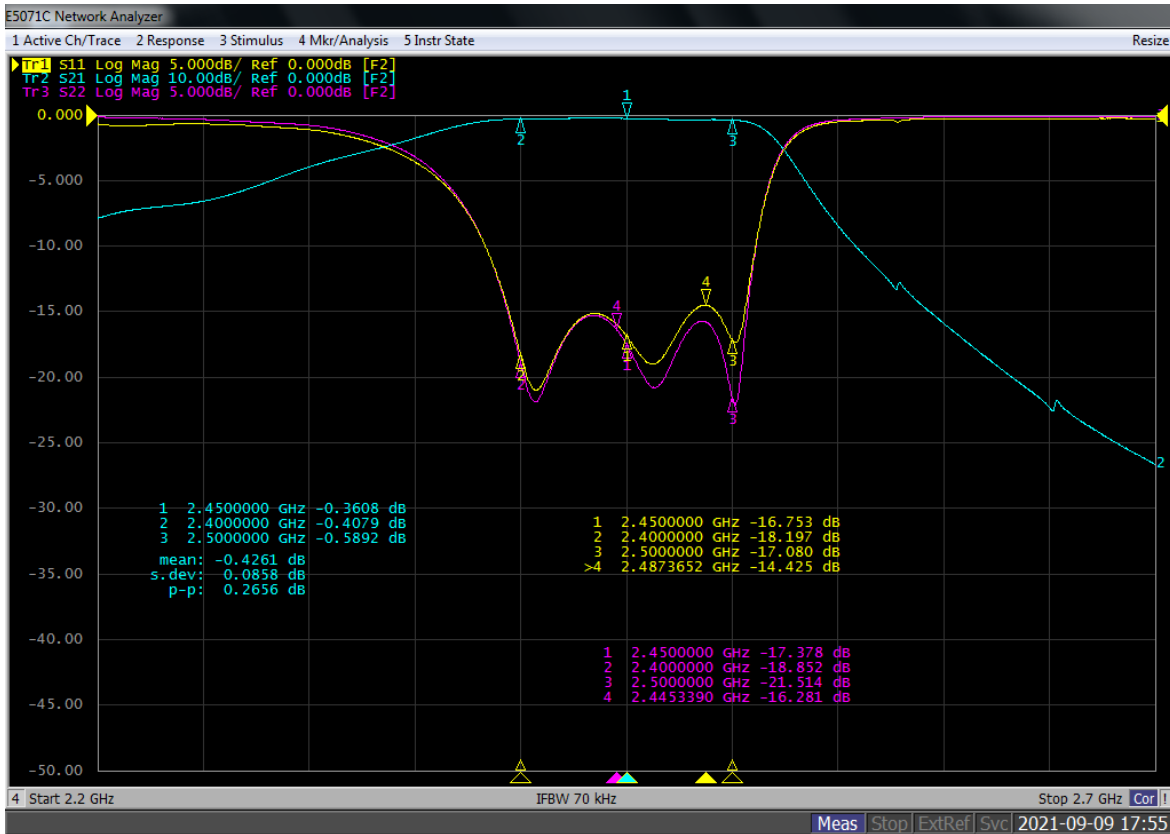

<P4>

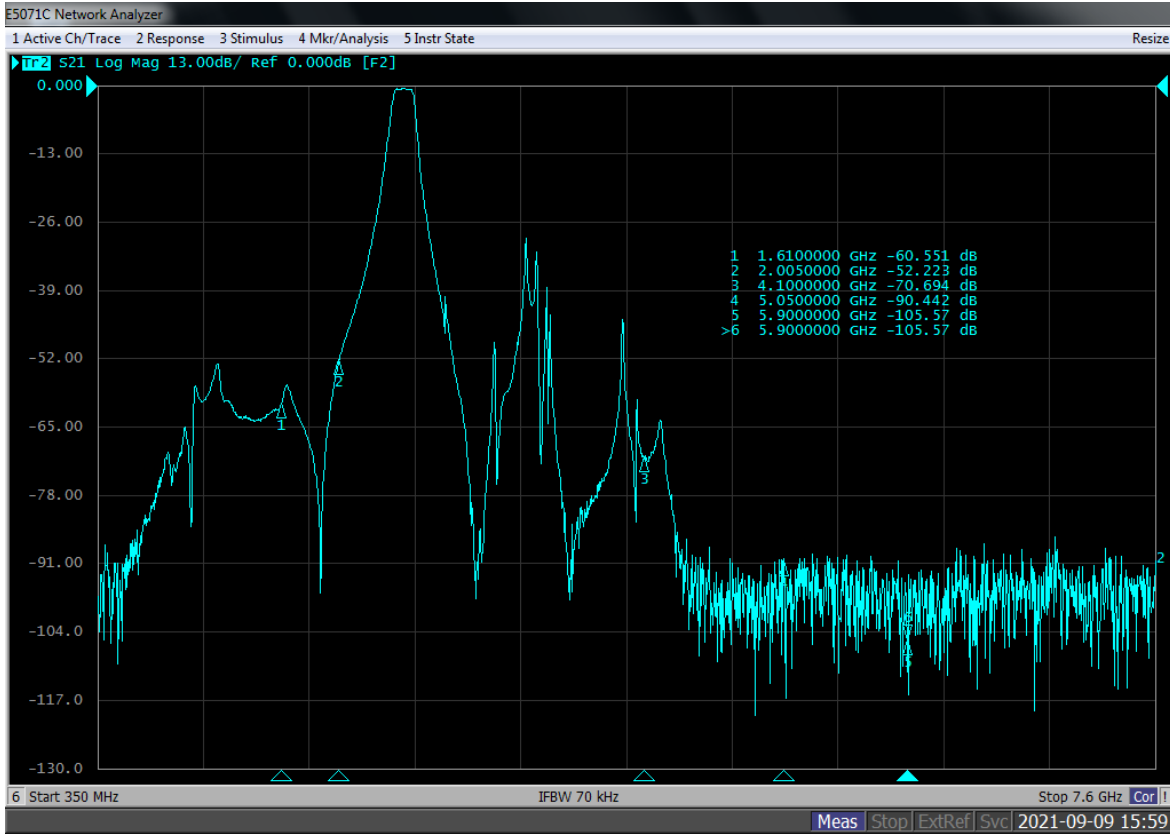

<P4 ISO>

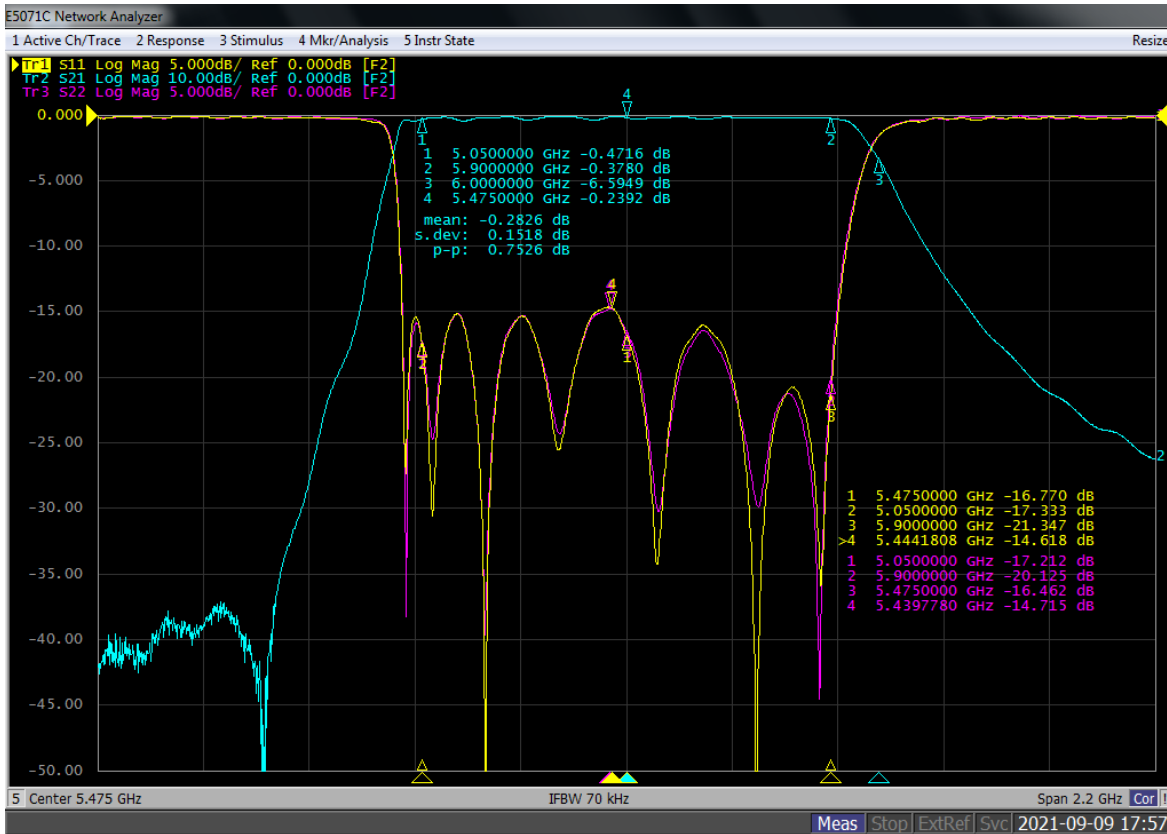

<P5>

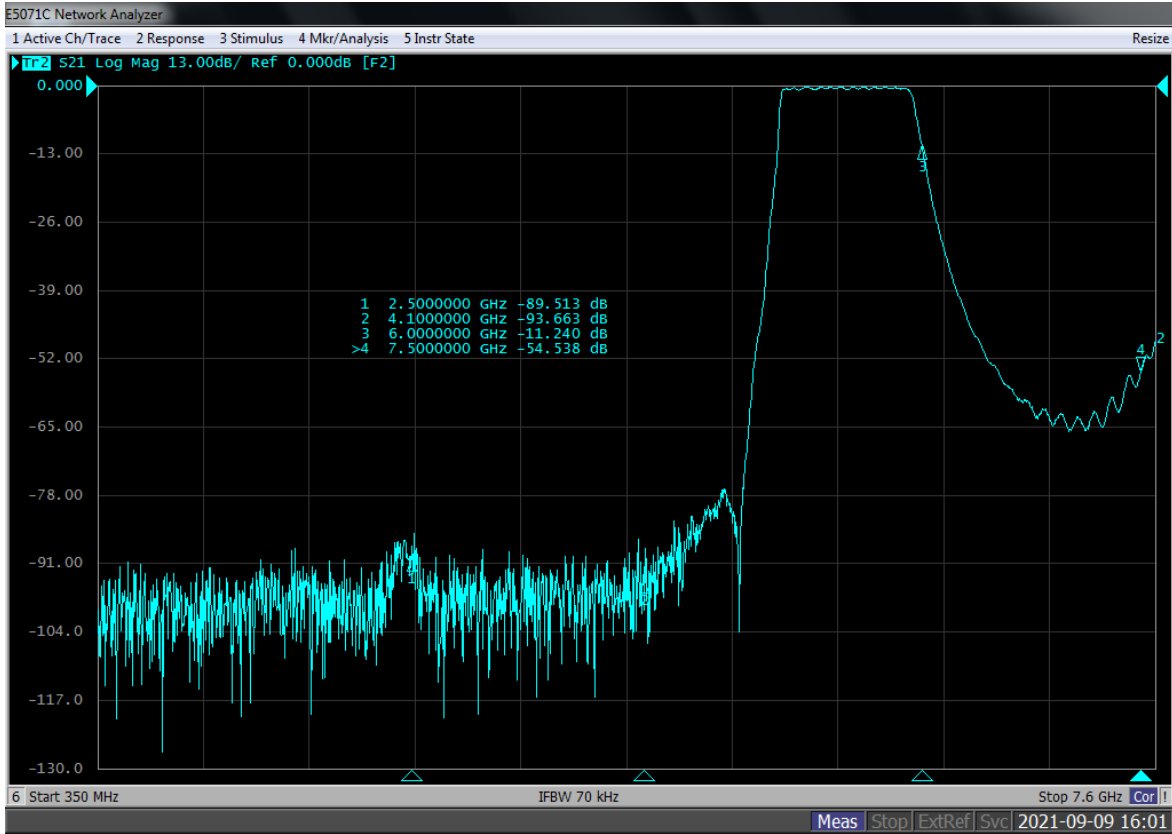

<P5 ISO>